

Spring plungers smooth version, stainless steel

Item description/product images



Description

Material:

Sleeve and spring stainless steel.
Ball stainless steel or POM.

Version:

Sleeve bright.
Steel ball hardened and bright.

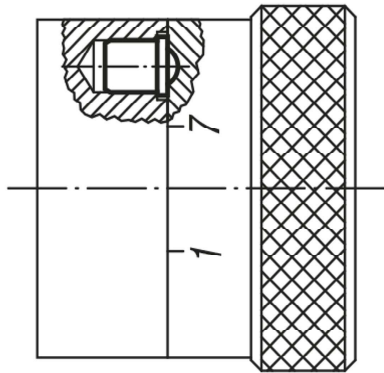

Drawings

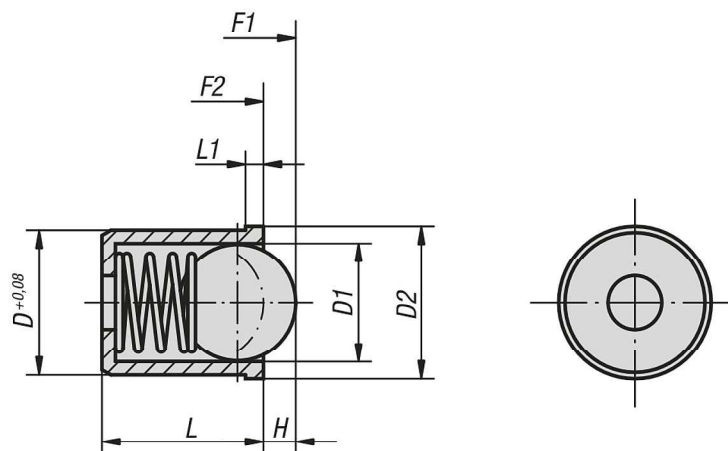

Overview of items

Spring plungers smooth version, stainless steel

Spring plungers smooth version, stainless steel

Overview of items

Order No.	Component material	D	D1	D2	L	L1	Travel S	Spring force initial pressure F1 approx. N	Spring force final pressure F2 approx. N
K0333.02	stainless steel	2	1,5	2,5	3	0,6	0,4	1,2	2,5
K0333.03	stainless steel	3	2,5	3,5	4	0,8	0,65	1,7	3,4
K0333.04	stainless steel	4	3	4,6	5	1	0,8	3	7
K0333.05	stainless steel	5	4	5,6	6	1	1	4	7
K0333.06	stainless steel	6	5	6,5	7	1	1,5	6	12
K0333.08	stainless steel	8	6,5	8,5	9	1	1,8	6	12
K0333.10	stainless steel	10	8	12	13,5	2,5	2,7	10	20
K0333.12	stainless steel	12	10	14	16	2,5	3,5	15	25
K0333.304	POM	4	3	4,6	5	1	0,6	3	7
K0333.305	POM	5	4	5,6	6	1	0,8	4	7
K0333.306	POM	6	5	6,5	7	1	1,3	6	12
K0333.308	POM	8	6,5	8,5	9	1	1,5	6	12
K0333.310	POM	10	8	12	13,5	2,5	2,6	10	20
K0333.312	POM	12	10	14	16	2,5	3,3	15	25